

Peacock

2-WAY TYPE (CUP & DIRECT DRINK) USER INSTRUCTION MANUAL

Thank you for purchasing our product. Before using please read this manual carefully to ensure the best possible performance. Please store your instruction manual in a safe place for future reference.

PARTS

For Lukewarm or Cold Drinks

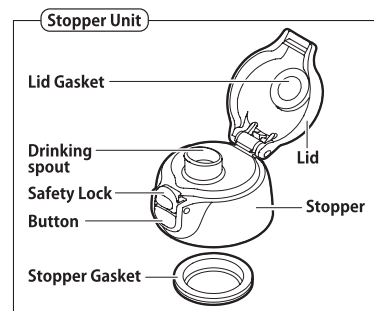

For Hot and Cold Drinks

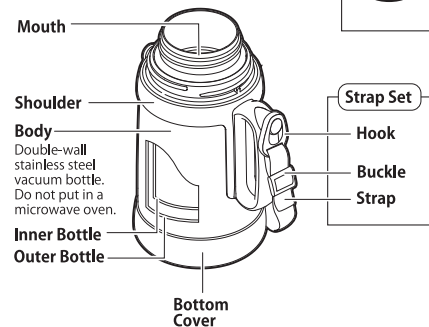
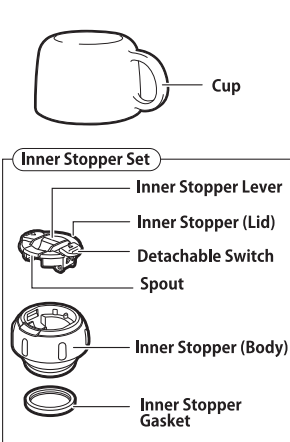

ASN MODEL

HOW TO REMOVE RUST SPOTS AND WATER STAINS

Depending on the water quality and the presence of impurities, it may lead to the development of rust spots or water stains on the inner bottle. To remove them, follow the instructions below.

- 1 Pour boiling water into the product, up to prescribed amount, and add approximately 10 g of citric acid.
- 2 After about three hours, wash the inner bottle with a long handled sponge brush, and rinse thoroughly with clean water.
- 3 Wipe off the moisture on the product and air dry thoroughly.
 - To prevent unpleasant odors and maintain hygiene, clean the product thoroughly before and after use.
 - When cleaning the product together with other items, be careful not to damage the product.

BEFORE CONTACTING US

Please check your product before you contact our service center. If none of the items described below applies to you, please contact the store where you purchased the product or our local distributor.

SYMPTOM	POINTS TO CHECK	ACTION
Drinks leak	Please check if the gaskets are properly and securely installed.	Make sure that each gasket is securely in place and installed in the correct position and direction.
	Please check if the stopper unit and inner stopper set are securely closed.	Firmly re-close the safety lock and stopper.
	Please check if the gaskets are clean with no foreign objects.	Clean the gaskets by following the instructions in "HOW TO CLEAN".
Beverage has unpleasant odor	Please check if there is too much beverage in the product.	Adjust the beverage amount down to prescribed amount.
	Was the beverage left in the product for a long period of time? Are there tea stains or any other stains on the inner bottle, stopper unit, stopper set, or gaskets?	Clean the product by following the instructions in "HOW TO CLEAN". If the stains are difficult to remove, use citric acid.
Product does not keep the beverage inside warm or cold	Was the beverage sufficiently hot (cold) when it was put in the product?	Fill the product up to prescribed amount with a sufficient hot (cold) beverage.

* Inner Stopper Gasket, Inner Stopper Set, Lid Gasket, Stopper Gasket, Stopper Unit are consumable parts. Please check every 6 months to 1 year for damage or deterioration.

AFTER PARTS SERVICE

We will keep the consumable parts mentioned in this manual for 5 years after the model has been discontinued for production. For any other product-related inquiries, please contact the store where you purchased the product or your local Peacock Distributor.

CONSUMABLE PARTS

Part name	ASN TYPE
Cup	Cup
Inner Stopper Set (Stopper Lid, Stopper Body, Inner Stopper Gasket)	Inner Stopper Set
Inner Stopper Gasket	Inner Stopper Gasket
Stopper Unit (Stopper, Stopper Gasket, Lid Gasket)	Stopper Unit
Stopper Gasket	Stopper Gasket
Lid Gasket	Lid Gasket
Bottom Cover	Bottom Cover
Strap Set (Hook, Buckle, Strap)	Strap Set

*See "PARTS" to cross-reference consumable parts and their names.



THE PEACOCK VACUUM BOTTLE CO.,LTD.

5-12-20, Sagisu, Fukushima-ku, Osaka, 553-0002, Japan
E-mail: peacockinquiry@the-peacock.co.jp

HOW TO CLEAN

- ◆ Always clean the product on the same day it was used.
- ◆ Always use a soft sponge for cleaning.
- ◆ Clean frequently to prevent unpleasant odors.

Outer bottle / Stopper set / Bottom Cover

Soak a sponge in water or lukewarm water with neutral kitchen detergent, wash and rinse thoroughly. After that, wipe off any moisture with dry cloth. *Do not presoak.

Inner bottle / Cup

Soak a long handle sponge brush, etc. in water or warm lukewarm with neutral kitchen detergent, wash and rinse thoroughly, and air dry to remove any moisture. *Do not presoak.

Gaskets / Drinking spout / Straw

Remove from the lid or stopper. Soak a sponge in water or lukewarm water with neutral kitchen detergent, wash and rinse thoroughly. After that, wipe off any moisture with dry cloth. Follow the instructions on ("HOW TO INSTALL GASKETS") to securely install it to the lid or stopper (any foreign object left on the gasket surface can cause the product to leak).

After cleaning the drinking spout and straw with a straw brush, rinse thoroughly and allow them to dry. Once dry, securely attach the stopper to the bottle by following the instructions in How to Attach Drinking Spout and Straw.

Inner Stopper Set (The Inner Stopper Set can be disassembled into the lid and the main body.)

Disassembly

- 1 Open the stopper lever.
- 2 Move the detachable switch in the direction of the arrow and pull up to remove the lid.

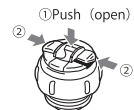

Install

Align the lid with the spout on the main body and push it until it clicks securely into place.

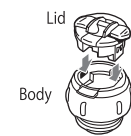

Soak a sponge in water or lukewarm water with neutral kitchen detergent, wash and rinse thoroughly. After that, wipe off any moisture with dry cloth. *Do not presoak.

Strap Set

Use a soft cloth moistened with warm water to wipe off any dirt. Then, dry it in the shade.

※ Do not soak or submerge the strap in water for cleaning.

WHEN CLEANING

Read the below instructions carefully before cleaning the product, and make sure to follow them.

- Do not use chlorine bleach. It may cause rusting, pinholes, and other damage.
- Do not use bleach on the outer bottle. There is a risk of rusting and coating damage.
- Remove the stopper unit when using oxygen bleach for the inner bottle. It causes a rise in pressure inside the body, which is dangerous (e.g., stopper unit may pop off).
- Do not use thinner, benzene, wire sponges, scrubbing brushes, polishing powder, abrasive cleaners, chemical rags, or other non-kitchen detergents. It causes scratches, rusting, and other damage.
- Do not boil use a dishwasher, dish dryer, etc. to clean or dry them. It causes scratches, rusting, deformation, leaks, and other damage.
- The entire body may be immersed in water for washing, but do not presoak it (leave it in water).
- After washing the body, make sure to wipe off any moisture. Any remaining moisture can cause droplet stains or rusting.
- When not using the product for extended periods of time, clean it carefully to remove any dirt, let it dry thoroughly, and store it away from high temperatures and humidity.

HOW TO INSTALL GASKETS

Improper installation can cause content to leak from the product.

If the gasket has been removed for cleaning or any other reason, read the instructions below to properly install it back in place.

Inner Stopper

How to install the inner stopper gasket

Open the inner stopper lever and ensure the valve is facing downward. Securely attach the gasket to the plastic part of the inner cap.

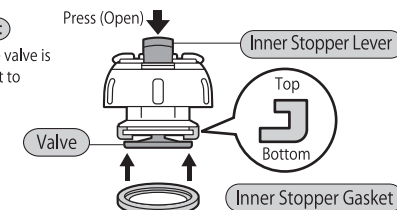

Stopper Unit

How to install the lid gasket

Press the concave portion of the lid gasket firmly over the protrusion on the lid. (please refer to the drawing below).

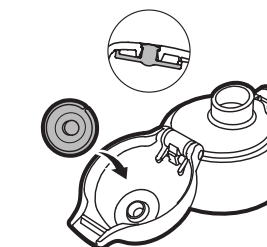

How to install the stopper gasket

Install the stopper gasket to the stopper (please refer to the drawing below).

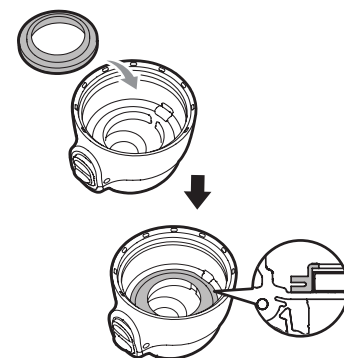

How to install and remove the strap set

- 1 Insert the hole of the hook into the protruding part of the handle.
 - 2 Pull the hook downward until it clicks into place.
- ※ To remove the hook, follow the procedure in reverse order of attaching the hook.

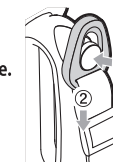

Actual product may vary from illustration in this manual.

SAFETY PRECAUTIONS

Use only for thermal retention of beverages

Never put in product

• Dry ice, carbonated beverages, etc.

Pressure inside the body will increase, causing the stopper set to become difficult to remove, the beverage to spurt out, or parts to break and possibly cause injury and other incidents.

• Soups and other salty content.

Cause of rusting and decline in thermal retention performance.

• Milk, milk-based beverages, fruit juice, etc.

Cause of decay, deterioration, and rusting. If the beverage is left inside the product over a long period, decay and deterioration can lead to gas emission, which increases pressure inside the body. This can cause the beverage to spurt out or parts to break, possibly resulting in injury and other incidents.

• Fruit pulp, tea leaves, etc. Cause of leaks and other damage.

• Keep the product out of reach of infants and small children and ensure that it is not played or tampered with.

There is a risk of scalding and injuries.

• Keep hot kettles from touching the mouth of the bottle.

The product may be knocked over, causing scalding, etc., or be damaged or deformed.

• If you add hot drinks to the container, always use a cup and do not drink directly from the bottle, as this may result in burns.

• Keep away from fire (heaters, stoves, etc.).

It may cause deformation and discoloration.

• Do not knock over, drop, hit, or apply strong impact to the product.

It can cause breakage, decline in thermal retention performance, rusting, coating damage, and content leakage.

• Do not place the product on its side. Contents may leak.

• Never put hot drinks in the bottle when using the stopper unit as this can cause burns, leaks, or other issues.

• Do not leave beverages inside the product over a long period. Cause of decay and deterioration.

• If the product is filled with a beverage, clean it immediately after use.

If you are unable to clean the product thoroughly due to being away from home or other reasons, make sure to promptly rinse the inside of the body with water. Clean the product sufficiently after you return home. Cause of molding, rusting, pinholes, and other damage.

• Never remove the protective sticker on the bottom of the body.

Risk of decline in thermal retention performance.

• Do not pour the liquid in the direction of the stopper as hot water may splash and cause burns or stains.

• Do not force large chunks of ice into the product. Break them up into smaller pieces that can be placed in the product easily. Do not jab with ice picks or other pointed objects.

Cause of scratches, leaks and other damage.

• Use the product with its stopper unit and lid and inner stopper set securely closed.

Risk of leaks, scalding, and other incidents.

• Always use the product with the gasket properly in place. Risk of leaks, scalding, and other incidents.

Cause of soiling of clothing.

• Do not carry the product by its stopper unit and cup and lid and inner stopper set.

• Do not tilt or turn the bottle upside down with the lid open when using the stopper unit, as this may cause liquid to spill and stain clothing.

• When placing the product in a bag, etc., place its body upright.

To prevent leaking, always place the body upright.

• Do not carry the product with PCs, mobile phones, digital cameras, or other precision equipment.

Beverage may leak, causing damage to precision equipment.

• Do not use the product while driving a car.

Cause of scalding and soiling of clothing.

• Do not modify or disassemble and repair the product.

Cause of breakage and accidents.

• Do not put the product in a freezer. Cause of leaks and other damage.

• Do not microwave.

Cause of sparks, which are dangerous. Cause of deformation and discoloration.

• Do not swing the product by the strap.

• Never play with the strap hanging around your neck, hook it onto nearby objects, or handle it roughly, as this can lead to accidents or malfunctions.

• If the product is placed on its side after pouring, or if cold water is stored for extended periods, residual droplets or condensation may leak from the spout of the inner stopper, potentially staining nearby items. In such cases, with the inner stopper lever and the spout facing down, gently shake the bottle up and down to release any water droplets.

• During use, moisture may appear on the back of the cup, the inner stopper, or around the bottle mouth. This is not a leak; it is condensation, where water vapor naturally condenses into droplets.

If you add hot drinks to the container (Cup • Inner Stopper Set)

• Hot tea may discolor if kept in the product for a long period of time. Use tea bags instead of tea leaves when bringing the tumbler away from home. Storing tea in the product to keep it warm can change its color and flavor. This is because components of the tea become altered over time.

• Leaving a hot beverage in the product for a long period of time can cause decompression inside the product, making the inner stopper lever difficult to remove or make noise upon removal.

• When using a product with a hot beverage inside, tilt the product slowly to pour the beverage.

Tilting it abruptly can cause the beverage to gush out, possibly resulting in scalding and other incidents.

• Do not shake the body immediately after putting a hot beverage in the product.

Doing this can cause an abrupt rise in internal pressure, making the inner stopper lever difficult to remove or make noise upon removal.

• Do not open the inner stopper lever near your face or with the product tilted.

If the product contains hot water, the water can gush out and splatter to possibly cause scalding.

Do not use the product if you hear the sound of water from inside its vacuum layer.

Thermal retention performance may have declined. Also, water accumulated in the vacuum layer can seep into the inner bottle, and drinking this water can cause health problems.

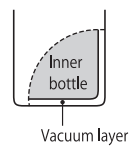

INSTRUCTIONS

Before using the product for the first time, wash the product.

Cup • Inner Stopper Set (For hot and cold drinks)

① Remove the cup • inner stopper set

Turn the stopper set counterclockwise.

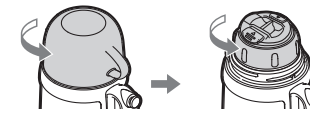

② Pour the beverage into the product

For better retention results, leave a small amount of hot or cold water in the product for about one minute in advance to preheat or precool the product. When pouring a beverage into the product, fill the product to no more than Prescribed Amount shown in the figure.

Closing the stopper set with too much beverage inside can cause the beverage to spurt out, or to leak out afterwards. If the product has been filled with too much of the beverage, adjust the amount down to Prescribed Amount before closing the stopper set.

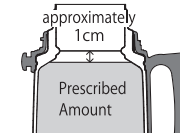

③ Close the inner stopper set

※ After closing the inner stopper set, ensure the stopper lever is fully lowered.

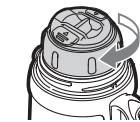

Turn the stopper set clockwise.

④ Pour the drink into the cup

※ Never push down the inner stopper lever while the bottle is tilted, as this may cause the drink to overflow.

※ If the inner stopper lever is too stiff to press, do not force it down. Instead, loosen the stopper, press the lever down with your finger, and then re-tighten the stopper.

Push (Open)

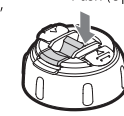

Push (Close)

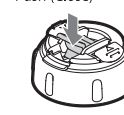

⑤ After Pouring

※ Hold the product upright for 2-3 seconds before pressing down on the spout with your finger.

※ A small amount of drink may remain around the spout or inside the cap, which could spill, especially if the product is placed on its side.

※ Tighten the cup slowly and securely all the way to the end.

Stopper Unit (For lukewarm or cold drinks)

① Remove the stopper unit

Turn the stopper set counterclockwise.

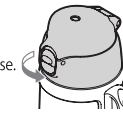

② Pour the beverage into the product

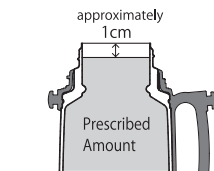

For better retention results, leave a small amount of hot or cold water in the product for about one minute in advance to preheat or precool the product. When pouring a beverage into the product, fill the product to no more than Prescribed Amount shown in the figure.

Closing the stopper set with too much beverage inside can cause the beverage to spurt out, or to leak out afterwards. If the product has been filled with too much of the beverage, adjust the amount down to Prescribed Amount before closing the stopper set.

③ Close the stopper set

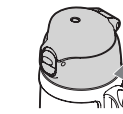

Turn the stopper set clockwise.

④ Open the lid and drink the beverage

① Unlock the Safety Lock.

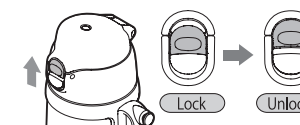

② Push the button to open the lid.

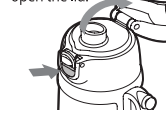

⑤ After drinking the beverage

After drinking the beverage close the lid securely, until you hear a click sound while keeping the product upright.

② Lock the Safety Lock.

