

Peacock

One Touch Mug Type USER INSTRUCTION MANUAL

Thank you for purchasing our product. Before using please read this manual carefully to ensure the best possible performance. Please store your instruction manual in a safe place for future reference.

AKE MODEL

PARTS

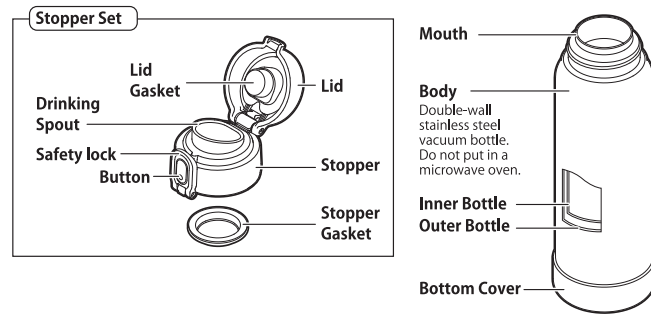

Actual product may vary from illustration in this manual.

HOW TO INSTALL GASKETS

Improper installation can cause content to leak from the product. If the stopper gasket has been removed for cleaning or any other reason, read the instructions below to properly install it back in place.

How to install the lid gasket

Press the concave portion of the lid gasket firmly over the protrusion on the lid.

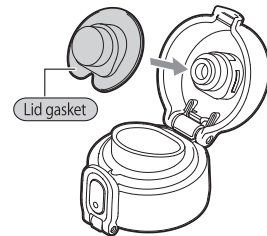

How to install the stopper gasket

Install the stopper gasket to the stopper (please refer to the drawing below).

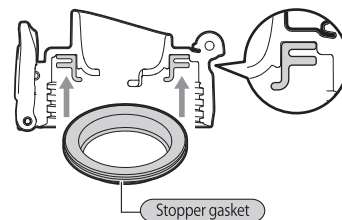

HOW TO CLEAN

- ◆ Always clean the product on the same day it was used.
- ◆ Always use a soft sponge for cleaning.
- ◆ Clean frequently to prevent unpleasant odors.

Outer bottle / Stopper set / Bottom cover

Soak a sponge in water or lukewarm water with neutral kitchen detergent, wash and rinse thoroughly. After that, wipe off any moisture with dry cloth. *Do not presoak.

Inner bottle

Soak a long handle sponge brush, etc. in water or warm lukewarm with neutral kitchen detergent, wash and rinse thoroughly, and air dry to remove any moisture. *Do not presoak.

Gaskets

Remove from the lid or stopper. Soak a sponge in water or lukewarm water with neutral kitchen detergent, wash and rinse thoroughly. After that, wipe off any moisture with dry cloth. Follow the instructions on ("HOW TO INSTALL GASKETS") to securely install it to the lid or stopper (any foreign object left on the gasket surface can cause the product to leak).

WHEN CLEANING

Read the below instructions carefully before cleaning the product, and make sure to follow them.

- **Do not use chlorine bleach.** It may cause rusting, pinholes, and other damage.
- **Do not use bleach on the outer bottle.** There is a risk of rusting and coating damage.
- **Remove the stopper set when using oxygen bleach for the inner bottle.** It causes a rise in pressure inside the body, which is dangerous (e.g., stopper set may pop off).
- **Do not use thinner, benzene, wire sponges, scrubbing brushes, polishing powder, abrasive cleaners, chemical rags, or other non-kitchen detergents.** It causes scratches, rusting, and other damage.
- **Do not boil the body or stopper set, or use a dishwasher, dish dryer, etc. to clean or dry them.** It causes scratches, rusting, deformation, leaks, and other damage.
- **The entire body may be immersed in water for washing, but do not presoak it (leave it in water).**
- **After washing the body, make sure to wipe off any moisture.** Any remaining moisture can cause droplet stains and rusting.
- **When not using the product for extended periods of time, clean it carefully to remove any dirt, let it dry thoroughly, and store it away from high temperatures and humidity.**

AFTER PARTS SERVICE

We will keep the consumable parts mentioned in this manual for 5 years after the model has been discontinued for production. For any other product-related inquiries, please contact the store where you purchased the product or your local Peacock Distributor.

CONSUMABLE PARTS

Part name	
AKE TYPE	Stopper Set (Stopper, Stopper Gasket, Lid Gasket)
AKE TYPE	Stopper Gasket
AKE TYPE	Lid Gasket
AKE TYPE ★	Bottom Cover

*See "PARTS" to cross-reference consumable parts and their names.
★Parts sizes vary depending on the body capacity.



THE PEACOCK VACUUM BOTTLE CO.,LTD.

5-12-20, Sagisu, Fukushima-ku, Osaka, 553-0002, Japan

E-mail: peacockinquiry@the-peacock.co.jp

HOW TO REMOVE RUST SPOTS AND WATER STAINS

Depending on the water quality and the presence of impurities, it may lead to the development of rust spots or water stains on the inner bottle. To remove them, follow the instructions below.

- ① **Pour boiling water into the product, up to prescribed amount, and add approximately 10 g of citric acid.**
- ② **After about three hours, wash the inner bottle with a long handled sponge brush, and rinse thoroughly with clean water.**
- ③ **Wipe off the moisture on the product and air dry thoroughly.**
 - To prevent unpleasant odors and maintain hygiene, clean the product thoroughly before and after use.
 - When cleaning the product together with other items, be careful not to damage the product.

BEFORE CONTACTING US

Please check your One Touch Mug Type before you contact our service center. If none of the items described below applies to you, please contact the store where you purchased the product or our local distributor.

SYMPTOM	POINTS TO CHECK	ACTION
Content leaks from lid/stopper	Please check if the gaskets are properly and securely installed.	Make sure that each gasket is securely in place and installed in the correct position and direction.
	Please check if the Safety lock and stopper are securely closed.	Firmly re-close the safety lock and stopper.
	Please check if the gaskets are clean with no foreign objects.	Clean the gaskets by following the instructions in "HOW TO CLEAN".
Beverage (Inner bottle or stopper) has unpleasant odor	Please check if there is too much beverage in the product.	Adjust the beverage amount down to prescribed amount.
	Was the beverage left in the product for a long period of time? Are there tea stains or any other stains on the body interior, stopper set, or gaskets?	Clean the product by following the instructions in "HOW TO CLEAN". If the stains are difficult to remove, use citric acid.
Product does not keep the beverage inside warm or cold	Was the beverage sufficiently hot (cold) when it was put in the product?	Fill the product up to prescribed amount with a sufficient hot (cold) beverage.

*The stopper gasket, and stopper set are consumable parts.
Please check every 6 months to 1 year for damage or deterioration.

SAFETY PRECAUTIONS

Use only for thermal retention of beverages

Never put in product

• Dry ice, carbonated beverages, etc.

Pressure inside the body will increase, causing the stopper set to become difficult to remove, the beverage to spurt out, or parts to break and possibly cause injury and other incidents.

• Soups and other salty content.

Cause of rusting and decline in thermal retention performance.

• Milk, milk-based beverages, fruit juice, etc.

Cause of decay, deterioration, and rusting. If the beverage is left inside the product over a long period, decay and deterioration can lead to gas emission, which increases pressure inside the body. This can cause the beverage to spurt out or parts to break, possibly resulting in injury and other incidents.

• Fruit pulp, tea leaves, etc. Cause of leaks and other damage.

• Keep the product out of reach of infants and small children and ensure that it is not played or tampered with.

There is a risk of scalding and injuries.

• Be careful of scalding when handling a product containing a hot beverage.

Due to insulation, the body exterior will not become hot even if the content is hot.

• Keep away from fire (heaters, stoves, etc.).

It may cause deformation and discoloration.

• When pouring a beverage into the product, fill the product only up to prescribed amount.

Exceeding the maximum can cause leaks, overflow, and scalding.

• If the product is filled with a beverage, clean it immediately after use.

If you are unable to clean the product thoroughly due to being away from home or other reasons, make sure to promptly rinse the inside of the body with water. Clean the product sufficiently after you return home. Cause of molding, rusting, pinholes, and other damage.

• Do not leave beverages inside the product over a long period.

Cause of decay and deterioration.

• Keep hot kettles from touching the mouth of the bottle.

The product may be knocked over, causing scalding, etc., or be damaged or deformed.

• Do not knock over, drop, hit, or apply strong impact to the product.

It can cause breakage, decline in thermal retention performance, rusting, coating damage, and content leakage.

• Never remove the protective seal on the bottom of the body.

Risk of decline in thermal retention performance.

• Do not place the product on its side. Contents may leak.

• Hot tea may discolor if kept in the product for a long period of time. Use tea bags instead of tea leaves when bringing the tumbler away from home.

Storing tea in the product to keep it warm can change its color and flavor. This is because components of the tea become altered over time.

• Leaving a hot beverage in the product for a long period of time can cause decompression inside the product, making the lid difficult to remove or make noise upon removal.

• When using a product with a hot beverage inside, tilt the product slowly to drink the beverage.

Tilting it abruptly can cause the beverage to gush out, possibly resulting in scalding and other incidents.

• Do not shake the body immediately after putting a hot beverage in the product.

Doing this can cause an abrupt rise in internal pressure, making the lid difficult to remove or make noise upon removal.

• Do not force large chunks of ice into the product. Break them up into smaller pieces that can be placed in the product easily. Do not jab with ice picks or other pointed objects.

Cause of scratches, leaks and other damage.

• Use the product with its stopper set securely closed. Securely close the Safety lock and tilt the body, etc., to make sure that the beverage does not leak.

Risk of leaks, scalding, and other incidents.

• Always use the product with the stopper gasket and lid gasket properly in place.

Risk of leaks, scalding, and other incidents. Cause of soiling of clothing.

• Do not carry the product by its stopper set.

• When placing the product in a bag, etc., place its body upright.

To prevent leaking, always place the body upright.

• Do not open the lid near your face or with the product tilted.

If the product contains hot water, the water can gush out and splatter to possibly cause scalding.

• Do not carry the product with PCs, mobile phones, digital cameras, or other precision equipment.

Beverage may leak, causing damage to precision equipment.

• Do not use the product while driving a car.

Cause of scalding and soiling of clothing.

Attempting to use the product while driving can distract the driver, which is dangerous.

• When using a car cup holder

① Use the cup holder only after checking its strength. If the cup holder lacks sufficient strength, it can break or become detached, risking scalding and other incidents or causing soiling of clothing.

② When using separately sold drink holders, use free-standing tumbler holders. Do not use hanging cup holders mounted on windows or air conditioner vents, for they can fall off.

• Do not modify or disassemble and repair the product.

Cause of breakage and accidents.

• Do not put the product in a freezer. Cause of leaks and other damage.

• Do not microwave.

Cause of sparks, which are dangerous. Cause of deformation and discoloration.

Do not use the product if you hear the sound of water from inside its vacuum layer.

Thermal retention performance may have declined. Also, water accumulated in the vacuum layer can seep into the inner bottle, and drinking this water can cause health problems.

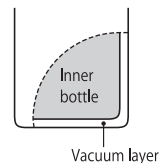

INSTRUCTIONS

Before using the product for the first time, wash the stopper set and body.

① Remove the stopper set

Turn the stopper set counterclockwise.

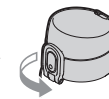

② Pour the beverage into the product

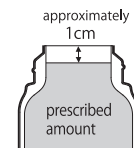

For better retention results, leave a small amount of hot or cold water in the product for about one minute in advance to preheat or precool the product. When pouring a beverage into the product, fill the product to no more than prescribed amount shown in the figure.

Closing the stopper set with too much beverage inside can cause the beverage to spurt out, or to leak out afterwards. If the product has been filled with too much of the beverage, adjust the amount down to prescribed amount before dosing the stopper set.

③ Close the stopper set

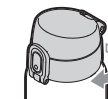

Turn the stopper set clockwise.

④ Open the lid and drink the beverage

① Unlock the safety lock.

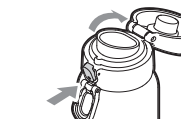
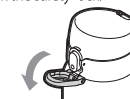

② Push the button to open the lid.

⑤ After drinking the beverage

① Close the lid

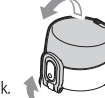

② Lock the safety lock.



After drinking the beverage close the lid securely, until you hear a click sound while keeping the product upright.